

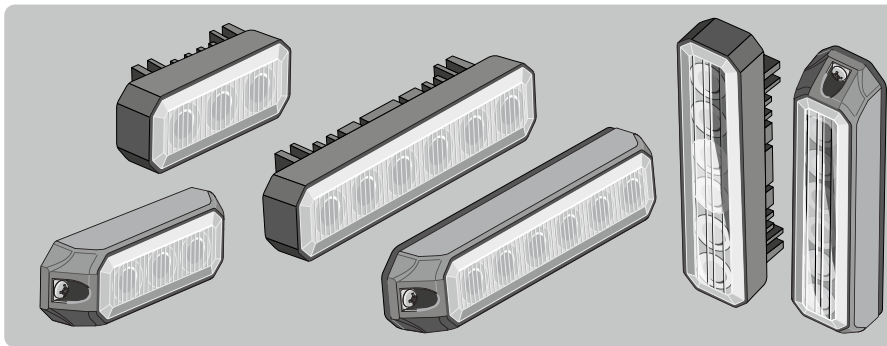

460 909-26 / 01.25



MONTAGEANLEITUNG

WARNLEUCHTE BST / BST-V MIT 3/6-LEDS

INSTALLATION INSTRUCTION

DIRECTIONAL WARNING LAMP BST / BST-V WITH 3/6-LED

INSTRUCTIONS DE MONTAGE

TÉMOIN BST / BST-V AVEC 3/6-LED

MONTERINGSANVISNING

VARNINGSLAMPA BST / BST-V MED 3/6-LED

MONTAGEHANDLEIDING

WAARSCHUWINGSLAMPJE BST / BST-V MET 3/6-LED

ISTRUCCIONES DE MONTAJE

6-LED LUZ DE ADVERTENCIA BST / BST-V CON 3/6-LED

ISTRUZIONI DI MONTAGGIO

SPIA LUMINOSA BST / BST-V CON 3/6-LED

ASENNUSOHJE

VAROITUSVALO BST / BST-V KANSSA 3/6-LED



Vor Steinschlag geschützt montieren!
Mount protected against stone chipping!
Monter à l'abri des chutes de pierres!
Montera skyddat från stenskott!



Tegen steenslag beschermd monteren!
¡Montar de manera que quede protegido
ante la acción de la gravilla!
Montare in modo che sia protetto
dall'urto di pietre!
Asenna suojaan kiveniskuilta!



Scheinwerfer darf nicht abgedeckt werden.
Headlamp must not be covered.
Ne pas recouvrir le projecteur
Strålkastaren får inte täckas över.
Schijnwerper mag niet worden afgedekt.
El faro no deberá taparse.
Non coprire il faro.
Valoa ei saa peittää.

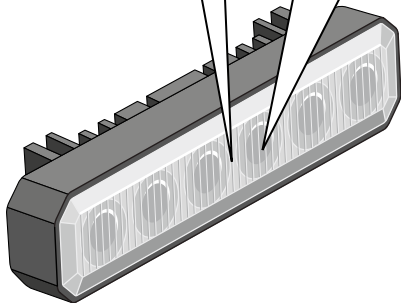
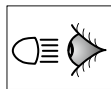

DE**PRODUKTHAFTUNG**

- Es sind die nationalen Anbau-, Einbau- und Betriebsvorschriften zu beachten und einzuhalten.
- Lesen Sie bitte vor Gebrauch des Gerätes alle beigelegten Anleitungen und Sicherheitshinweise.
- Im Zuge von Produktverbesserung behalten wir uns technische und optische Änderungen vor.
- Verwenden Sie nur die Originalersatzteile bzw. nur Ersatzteile die von HELLA freigegeben sind.
- Bei Fragen oder Einbauproblemen, rufen Sie den HELLA Kundendienst, Großhändler an oder wenden Sie sich an Ihre Vertragswerkstatt.

EN**PRODUCT LIABILITY**

- National mounting, fitting and operating regulations must be heeded and kept.
- Please read all the instructions and safety notes included before using the device.
- We reserve the right to make technical and optical modifications within the course of product improvement.
- Only use original spare parts or spare parts approved by HELLA.
- If you have any questions or installation problems, call HELLA customer services, your wholesaler or contact your specialist garage.

FR**RESPONSABILITÉ PRODUIT**

- Les prescriptions nationales en matière de montage et de service doivent être observées et respectées.
- Avant d'utiliser l'appareil lire toutes les instructions de montage et de service fournies ainsi que les conseils de sécurité
- Dans le cadre de l'amélioration continue de nos produits, nous nous réservons le droit de réaliser des modifications sur les plans technique et optique.
- Utilisez uniquement des pièces d'origine ou des pièces de rechange validées par HELLA.
- Pour tous renseignements ou problèmes de montage, contactez le S.A.V. HELLA, votre distributeur ou votre garage lié par contrat.

SV**PRODUKTANSVAR**

- De nationella monterings-, installations- och driftföreskrifterna ska beaktas och följas.
- Läs alla medföljande instruktioner och säkerhetsanvisningar innan du använder apparaten.
- Vi förbehåller oss rätten till tekniska och optiska ändringar som förbättrar produkten.
- Använd endast original reservdelar resp. endast reservdelar som har godkänts av HELLA.
- Om du har frågor eller problem med installationen, ring HELLA kundtjänst, partihandlaren eller vänd dig till din märkesverkstad.

NL**PRODUCTAANSPRAKELIJKHEID**

- Men dient de nationale aanbouw-, inbouw- en bedrijfsvoorschriften in acht te nemen en na te leven.
- Lees a.u.b. alvorens het apparaat te gebruiken alle bijgevoegde gebruiksaanwijzingen en veiligheidsinstructies door.
- In het kader van de productver-betering behouden wij ons technische en optische veranderingen voor.
- Gebruik uitsluitend de originele reserveonderdelen, die door Hella vrijgegeven zijn.
- Bij vragen of inbouwproblemen dient u de HELLA klantenservice, de groothandel te bellen of u te richten tot de dealerwerkplaats.

ES**RESPONSABILIDAD CIVIL POR PRODUCTOS DEFECTUOSOS**

- Tienen que observarse y cumplirse con las prescripciones nacionales sobre construcciones anexas, de montaje y de funcionamiento.
- Rogamos que antes de usar el aparato lean todas las instrucciones y advertencias sobre la seguridad adjuntas.
- En aras de la mejora de los productos, nos reservamos el derecho de hacer modificaciones técnicas y ópticas.
- Use sólo recambios originales o bien sólo recambios autorizados por HELLA.
- Si tiene preguntas que hacernos o dificultades en el montaje, llame al Servicio de Atención al Cliente de HELLA, a los mayoristas o diríjase a su taller concesionario.

IT

RESPONSABILITÀ PER IL PRODOTTO

- Si devono rispettare tutte le normative nazionali di attacco, montaggio e funzionamento.
- Prima di usare l' apparecchio, legga per favore tutte le istruzioni e le avvertenze di sicurezza allegate.
- Nell' ambito del perfezionamento del prodotto, ci riserviamo modifiche tecniche ed estetiche.
- Utilizzare solo pezzi di ricambio originali risp. pezzi autorizzati dalla HELLA.
- In caso di domande o problemi di montaggio, chiami il servizio di assistenza dei clienti della HELLA, il rivenditore o si rivolga alla Sua officina autorizzata.

FI

TUOTEVASTUU

- Kansalliset asennus- ja käyttöohjeet on huomioitava ja niitä on noudatettava.
- Lue ennen laitteen käyttöä kaikki oheistetut käyttö- sekä turvaohjeet.
- Jatkuvasta tuotekehittelystä johtuen pidätämme oikeuden teknisiin ja optisiin muutoksiin.
- Käytä vain alkuperäisiä tai HELLA hyväksymiä varaosia.
- Jos Sinulla on kysymyksiä tai asennusongelmia, soita HELLA-asiakaspalveluun, tukkukauppiaille tai käänny sopimuskorjaamon puoleen.

- DE** Technische Änderungen vorbehalten
- EN** Subject to alteration without notice
- FR** Sous réserve de modifications techniques
- SV** Vi reserverar oss för tekniska ändringar
- NL** Technische wijzigingen voorbehouden
- ES** Reservadas modificaciones técnicas
- IT** Con riserva di modifiche tecniche
- FI** Oikeus teknisiin muutoksiin pidätetään

Lieferumfang
Scope of delivery
Fourniture

Leveransomfattning
Leveringsomvang
Alcance de suministro

Contenuto della confezione
Toimituksen sisältö
Isporuka obuhvata

BST

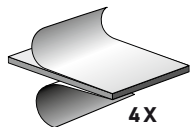
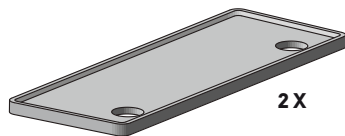
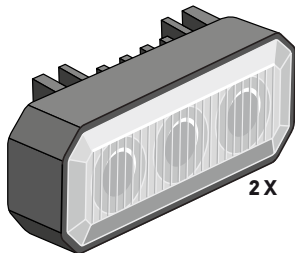

BST

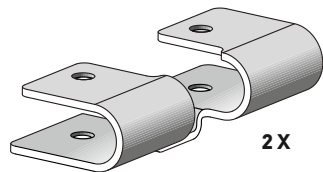
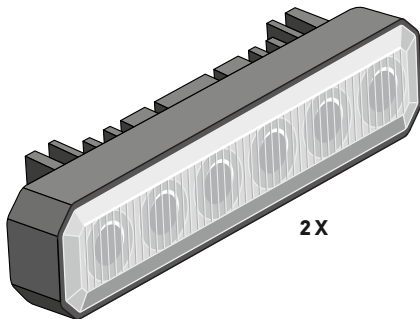

Lieferumfang
Scope of delivery
Fourniture

Leveransomfattning
Leveringsomvang
Alcance de suministro

Contenuto della confezione
Toimituksen sisältö
Isporuka obuhvata

BST

2X

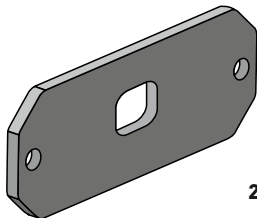

2X

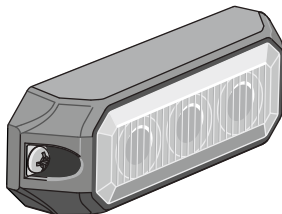

4X

8

BST

2X

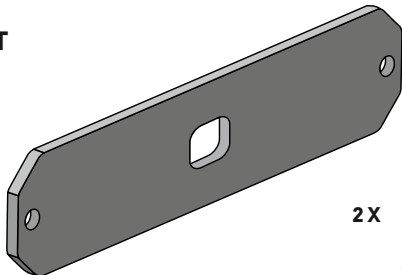

2X

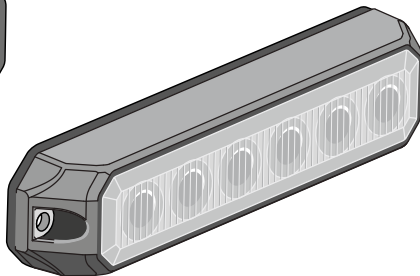

4X

Lieferumfang
Scope of delivery
Furniture

Leveransomfattning
Leveringsomvang
Alcance de suministro

Contenuto della confezione
Toimituksen sisältö
Isporuka obuhvata

BST-V

2X

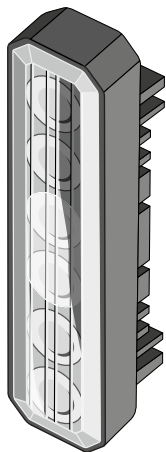

8X



4X

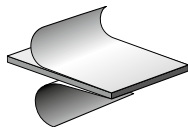

4X

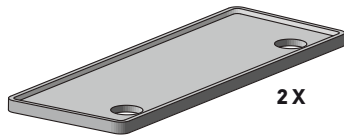

2X

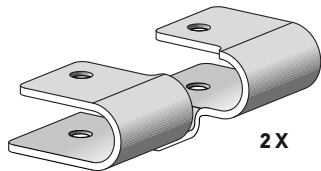

2X

Lieferumfang
Scope of delivery
Furniture

Leveransomfattning
Leveringsomvang
Alcance de suministro

Contenuto della confezione
Toimituksen sisältö
Isporuka obuhvata

BST-V

2 X

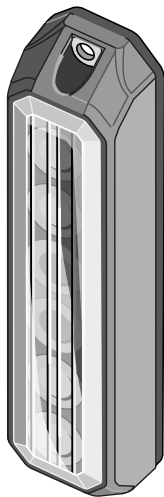

2 X

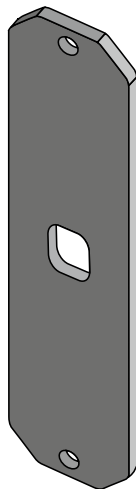

4 X



Zubehör
Accessories
Accessories

Tillbehör
Toebehoren
Accessorios

Accessori
Lisätarvikkeet



8JD 005 235-801



8KW 732 567-003

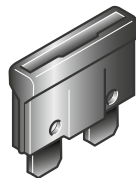

3A 8JS 711 683-821

Benötigte Montagewerkzeuge
Installation tools required
Outillage de montage requis

Nödvändiga monteringsverktyg
Benodigde montagewerktuigen
Herramientas de montaje necesarias

Attrezzi necessari per il montaggio
Tarvittavat asennustyökalut

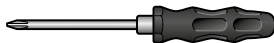
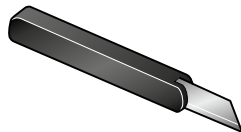
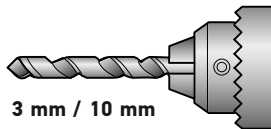
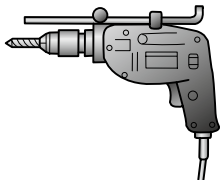

Anbaumaße
Headlight installation
Montage des projecteurs

Montering av lampan
Montage van de koplampen
Montaje de los faros

Montaggio dei proiettori
Ajovalojen asennus

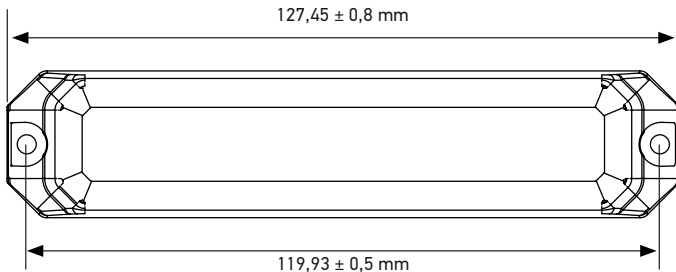

$17,61 \pm 0,8$ mm

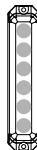
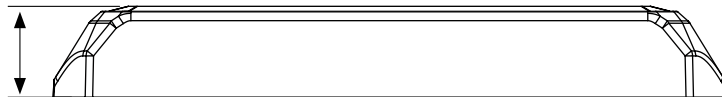

$27,82 \pm 1$ mm

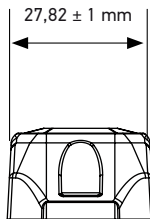

Anbaumaße
Headlight installation
Montage des projecteurs

Montering av lampor
Montage van de koplampen
Montaje de los faros

Montaggio dei proiettori
Ajovalojen asennus

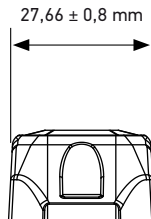
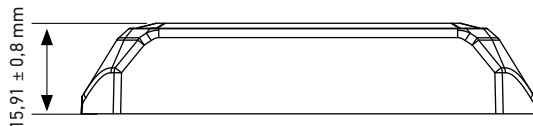
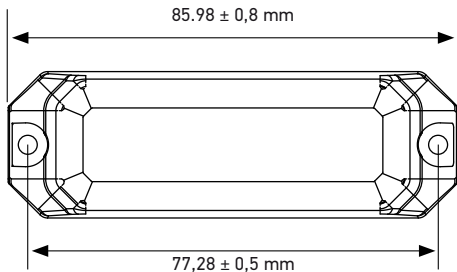

Anbaumaße
Headlight installation
Montage des projecteurs

Montering av lampan
Montage van de koplampen
Montaje de los faros

Montaggio dei proiettori
Ajovalojen asennus

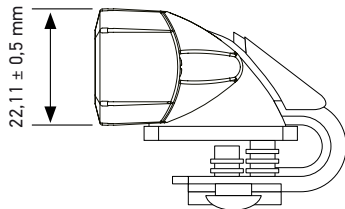
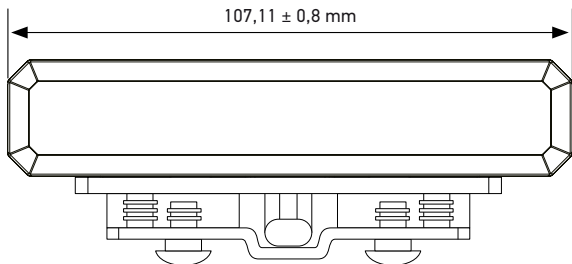
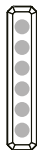
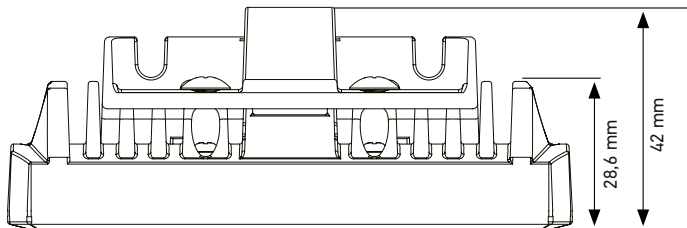

Anbaumaße
Headlight installation
Montage des projecteurs

Montering av lampor
Montage van de koplampen
Montaje de los faros

Montaggio dei proiettori
Ajovalojen asennus

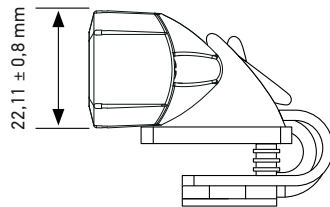
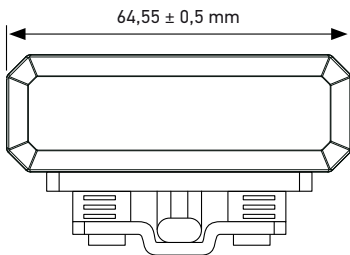
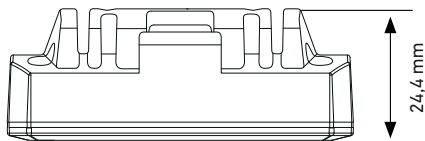

Anbaumaße
Warning light installation
Montage des projecteurs

Montering av lampan
Montage van de koplampen
Montaje de los faros

Montaggio dei proiettori
Ajovalojen asennus

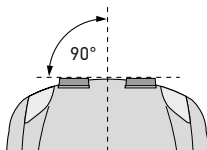
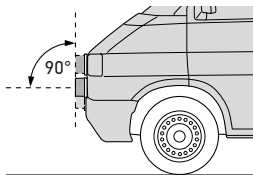

DE

Es sind die nationalen Anbau-Einbau und Betriebsvorschriften zu beachten und einzuhalten, insbesondere zum Fußgängerschutz. Prüfen Sie vor dem Anschluß der Warnblitzfunktion, ob Sie entsprechend der örtlichen Rechtsvorschriften zu dem Personenkreis gehören, der Warnblitzer in der montierten Richtung nutzen darf.

EN

National mounting, installation and operating regulations must be heeded and kept, particularly those relating to pedestrian protection. Before you connect the integrated warning lights, please check if local regulations allow you to use the LED directional warning lights in the installed direction.

FR

Observer et respecter les prescriptions de montage, de construction et d'exploitation nationales en vigueur, en particulier la protection des piétons. Avant de connecter la fonction de feux d'avertissement intégrés, veuillez vérifier si vous faites partie du cercle de personnes autorisées conformément à la législation locale à utiliser les feux LED de signalisation directionnelle dans le dispositif monté.

SV

Beakta och följ nationella påbyggnads-, monterings- och driftföreskrifter, särskilt avseende fotgängarskydd. Innan du ansluter den integrerade varningsljusfunktionen, måste du kontrollera att du tillhör den grupp personer som enligt lokal lagstiftning har rätt att använda LED-riktningsvarningsljus i den monterade riktningen.

Anbaumaße
Warning light installation
Montage des projecteurs

Montering av lampor
Montaje van de koplampen
Montaje de los faros

Montaggio dei proiettori
Ajovalojen asennus

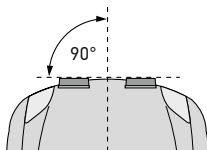
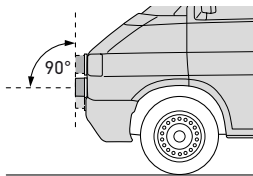

18

NL

De nationale aanbouw-, inbouw- en bedrijfsvoorschriften moeten in acht worden genomen, in het bijzonder de voorschriften inzake de bescherming van voetgangers. Controleer voordat u de geïntegreerde waarschuwingslichtfunctie aansluit of u tot de groep personen behoort die volgens de plaatselijke wetgeving LED-richtingwaarschuwingslichten mogen gebruiken.

ES

Se deben observar y cumplir las normas nacionales de montaje, instalación y explotación, especialmente aquellas que tienen que ver con la protección de los peatones. Antes de conectar la función de luces de advertencia integradas, compruebe si pertenece al grupo de personas autorizadas a utilizar las luces LED direccionales de advertencia en la dirección instalada de acuerdo con la legislación local.

IT

Osservare e rispettare le norme nazionali di montaggio a incasso, montaggio a sbalzo e funzionamento, in particolare quelle per la protezione dei pedoni. Prima di collegare la funzione di luci lampeggianti, verificare se si appartiene al gruppo di persone autorizzate a utilizzare le luci LED di avvertimento nella direzione installata, in conformità alla legislazione locale.

FI

Kansallisia asennus- ja käyttöohjeita on noudatettava, erityisesti koskien jalankulkijoiden suojausta. Tarkista ennen integroidun välkkyvalotoiminnon liitäntää, että kuuluu paikallisen lainsäädännön mukaan siihen joukkoon, joka saa käyttää LED-suuntaavia varoitusvaloja asennetussa suunnassa.

Klebmontage
Adhesive Mount
Montage avec adhésif

Självhäftande montering
Lijmning
Montaje adhesivo

Montaggio adesivo
Liimakiinnitys

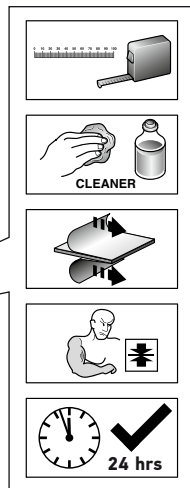
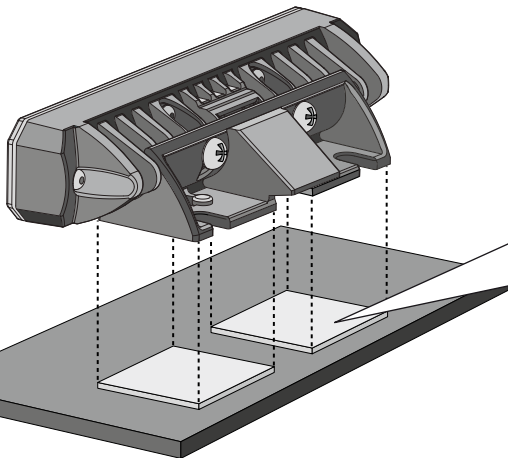
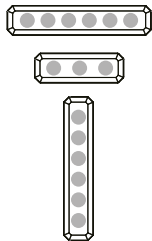

Schraubmontage
Screw Mount
Montage par vis

Skruvmontering
Schroefmontage
Montaje con tornillos

Montaggio a vite
Ruuvikiinnitys

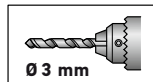
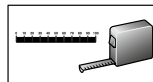
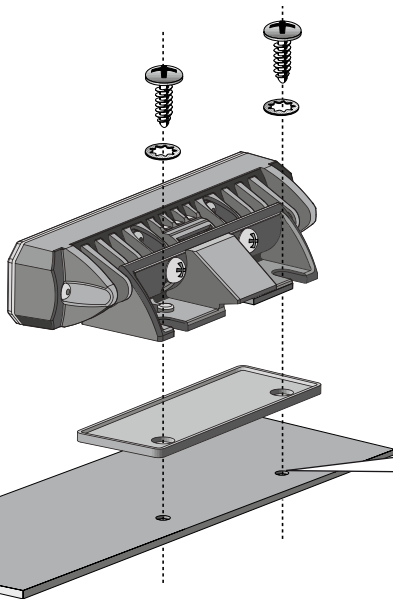
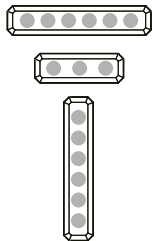

Klemmmontage
Bracket Mount
Montage sur support

Montering på konsol
Beugelmontage
Montaje con soportes

Montaggio a staffa
Telinekiinnitys

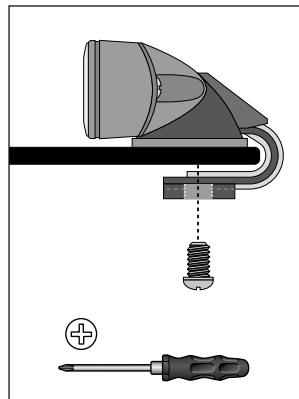
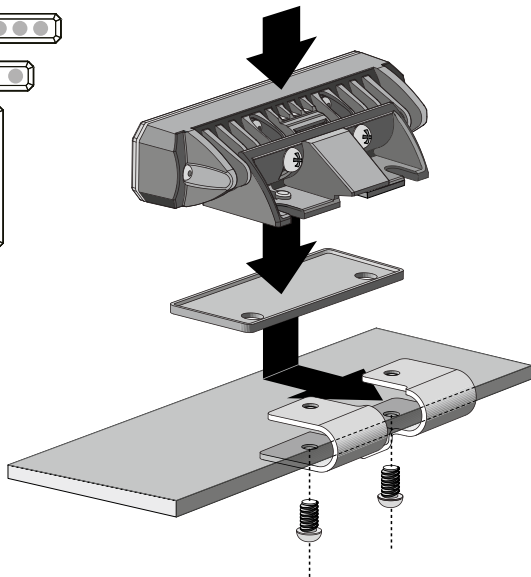
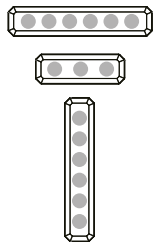

Schraubmontage
Screw Mount
Montage par vis

Skruvmontering
Schroefmontage
Montaje con tornillos

Montaggio a vite
Ruuvikiinnitys

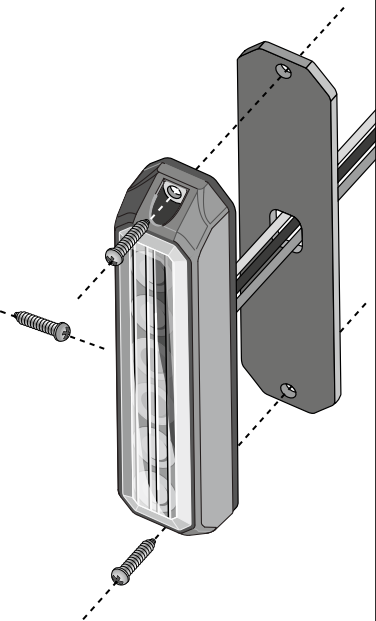
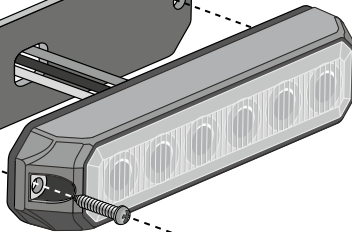
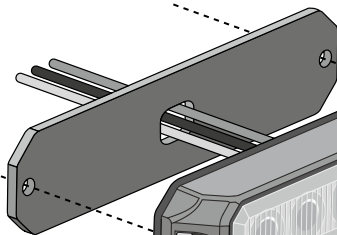

DE**ALLGEMEINE HINWEISE**

- Teile gemäß Abbildung montieren
- Zur Vermeidung von Beschädigungen an der Leitungsisolierung ist eine Berührung mit scharfen Kanten zu vermeiden
- Gesetzlichen Bestimmungen des jeweiligen Landes beachten
- Blaue Warnleuchten nur für bevorrechtigte Wegbenutzer
- Blaue Warnleuchten nur in Verbindung mit Kennleuchten benutzen

EN**GENERAL POINTS**

- Assemble parts according to the illustrations and instructions. Make sure that the harness and other parts are positioned correctly and exactly.
- To avoid damage to the cable insulation, avoid contact with sharp edges.
- National legislation must always be heeded.
- Blue warning lights are only for priority road users.
- Blue warning lights can only be used in connection with beacons.

FR**REMARQUES GÉNÉRALES**

- Monter les pièces conformément aux illustrations et aux indications. Veillez à ce que le faisceau de câbles et les autres éléments soient positionnés correctement et avec précision.
- Pour ne pas risquer d'endommager l'isolation des câbles, évitez le contact avec des angles affûtés.
- Il faut dans tous les cas respecter les lois en vigueur dans le pays.
- Feux de signalisation bleus uniquement pour les usagers privilégiés de la voie.
- N'utilisez les feux de signalisation bleus qu'avec des feux rotatifs.

SV**ALLMÄNNA ANVISNINGAR**

- Montera delarna enligt bilderna och anvisningarna. Se till att kabelstammen och övriga delar är korrekt och exakt positionerade.
- Undvik beröring med vassa kanter för att undvika skador på ledningsisolationen.
- I varje fall måste den i landet gällande lagstiftningen iakttas.
- Blå varningslampor endast för förmånsberättigade trafikanter.
- Använd endast blå varningslampor i kombination med utryckningslampor.

NL**ALGEMENE INSTRUCTIES**

- Onderdelen volgens de afbeeldingen en aanwijzingen monteren. Zorg ervoor, dat de kabelboom en de andere onderdelen reglementair en nauwkeurig gepositioneerd zijn.
- Om beschadigen aan de leidingsisolatie te voorkomen, moet contact met scherpe randen vermeden worden.
- In elk geval moet de landspecifieke wetgeving nageleefd worden.
- Blauwe waarschuwinglampen uitsluitend voor bevoorrechtigde weggebruikers.
- Blauwe waarschuwinglampen uitsluitend in combinatie met zwaailichten gebruiken.

ES**INDICACIONES GENERALES**

- Monte las piezas siguiendo las ilustraciones y las indicaciones. Procure que el cableado y las demás piezas estén colocadas de forma reglamentaria y en la posición exacta.
- Para evitar daños en el aislamiento del cableado, se deberá evitar el contacto con superficies afiladas.
- En cualquier caso ha de respetarse la legislación local.
- Luces de aviso sólo para usuarios prioritarios de la calzada.
- Emplee la luz de aviso únicamente en combinación con las luces de identificación.

IT**AVVERTENZE GENERALI PER IL LAVAGGIO**

- Montare i pezzi secondo le figure e le istruzioni. Accertarsi che il fascio cavi e altri pezzi siano posizionati regolarmente e in modo preciso.
- Per evitare danni all'isolamento dei cavi occorre evitare di toccarlo con bordi taglienti.
- In ogni caso occorre rispettare la normativa specifica per il paese in questione
- I proiettori spia azzurri sono destinati esclusivamente ad utenti della strada preferenziali.
- I proiettori spia azzurri vanno utilizzati esclusivamente con i proiettori di riconoscimento.

FI**YLEISOHJEITA**

- Asenna osat kuvien ja ohjeiden mukaisesti. Huolehdi siitä, että kaapelipuu ja muut osat on asennettu asianmukaisesti ja tarkkaan.
- Vältä koskettamasta johtojen eristeitä terävillä kulmilla, jotta ne eivät vahingoitu.
- Maakohtaista lainsäädäntöä on noudatettava aina.
- Siniset varoitusvalot on tarkoitettu vain etuoikeutetuille tien käyttäjille.
- Sinisiä varoitusvaloja saa käyttää vain merkkivalojen kanssa.



Elektrische Verbindung / Aufbaumontage

- ROT ←
Zu +VDC (3A-Sicherung)
- SCHWARZ ←
Zur Fahrgestellerde
- GELB ←
- WEISS ←
low power / night mode (014.560-xxx)

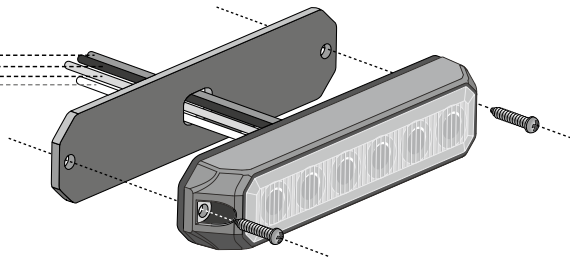

26

Synchronisierung:

Die GELBEN Leitungen aller BST für die Synchronisierung miteinander verbinden (alle BST müssen auf dasselbe Muster eingestellt werden)

Simultane oder alternierende Blinksignale:

1. +VDC gleichzeitig an die ROTEN und GELBEN Leitungen anlegen, um den Gruppenmodus aufzurufen: BST gibt kurze (einzelne oder doppelte) Blinksignale ab:

- Einzelblinksignal = Gruppe 1
- Doppelblinksignal = Gruppe 2

2. Die GELBE Leitung von +VDC trennen und kurz mit +VDC verbinden, um die Gruppen zu wechseln:

- BST in derselben Gruppe blinken gleichzeitig.
- Gruppe 1-BST alternierend mit Gruppe 2-BST.

Auswahl der Blinkmuster:

Kurz +VDC an GELBE Leitung anlegen:

- einmal für nächstes Muster
- 3-mal kurz hintereinander für Reset

FP-Nr.	Blinkmuster:
1	Einfach *
2	Zweifach *
3	Dreifach *
4	Vierfach *
5	Dauerlicht

*** Für den Betrieb der Leuchte im Europäischen Raum sind nur die Blinkmuster 1, 2, 3 und 4 zulässig.**



Electrical connection / Surface Mount

- RED ←
To +VDC (fuse @ 3A)
- BLACK ←
To Chassis Ground
- YELLOW ←
- WHITE ←
low power / night mode (014.560-xxx)

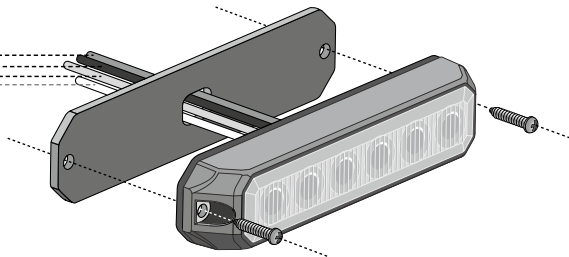

27

For Synchronization:

Connect YELLOW wires of all heads together for synchronization (all heads must be set at the same pattern)

For Simultaneous or Alternating Flash:

1. Apply +VDC to RED and YELLOW wires simultaneously to enter Grouping mode; lighthead will display short (single or double) flashes:

- Single flash = Group 1
- Double flash = Group 2

2. Remove YELLOW wire from +VDC and momentarily apply to +VDC to change Groups:

- Heads in the same Group flashtogether.
- Group1 Heads alternate with Group2 Heads.

For Flash Patterns:

Momentarily apply +VDC to YELLOW wire:

- once for next pattern
- quickly three times for pattern 0

FP-Nr.	Blinkmuster:
1	Single *
2	Double *
3	Triple *
4	Quadruple *
5	Steady

* **Only the flash patterns 1, 2, 3, and 4 are approved for use in Europe.**

- ROUGE ←
Vers +VCC (fusible de 3 A)
- NOIR ←
Vers terre du châssis
- JAUNE ←
- BLANC ←
low power / night mode (014.560-xxx)

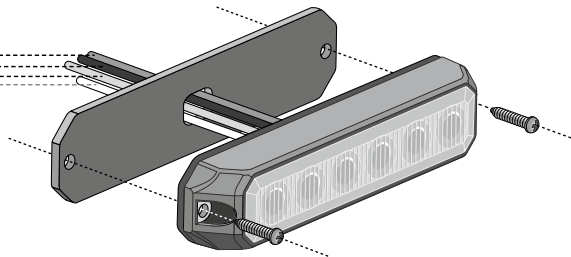

Pour la synchronisation :
Connecter ensemble les câbles JAUNES de toutes les têtes pour la synchronisation (toutes les têtes doivent être réglées sur la même séquence)

Pour un éclat simultané ou en alternance :

1. Appliquer simultanément le +VCC aux câbles ROUGE et JAUNE pour entrer dans le mode groupement ;
la tête du feu émettra des éclats courts (simples ou doubles) :

- Éclat simple = groupe 1
- Éclat double = groupe 2

2. Connecter temporairement le câble JAUNE au câble ROUGE pour modifier la séquence d'éclats :

- Les têtes du même groupe produisent des éclats ensemble.
- Les têtes du groupe 1 alternent avec les têtes du groupe 2.

Pour les séquences d'éclats :
Appliquer temporairement le +VCC au câble JAUNE :

- une fois pour la prochaine séquence
- trois fois rapides pour la séquence 0

FP-Nr.	Blinkmuster:
1	Simple *
2	Double *
3	Triple *
4	Quadruple *
5	Continu

* **Seuls les modèles de clignotements 1, 2, 3, et 4 sont autorisés pour un fonctionnement du feu dans l'espace européen.**



Elanslutning / Ytmontering

- RÖD ←
Till +V DC (säkring 3 A)
- SVART ←
Till chassijord
- GUL ←
- VIT ←
low power / night mode (014.560-xxx)

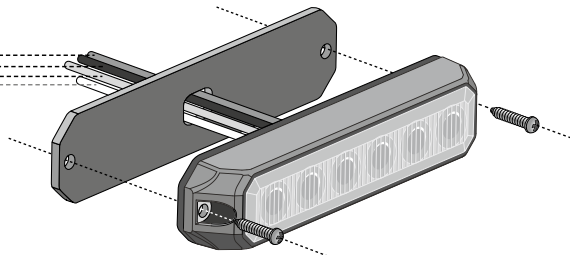

29

För synkronisering:

Anslut alla huvudenas GULA ledare tillsammans för att synkronisera dem (alla huvudena måste ställas in med samma mönster)

För samtidig eller omväxlande blinkning:
1. Lägg på +V DC på de RÖDA och GULA ledarna samtidigt för att gå till grupperingsläget.

Lamphuvudet visar korta (enkla eller dubbla) blinkningar:

- Enkel blinkning = Grupp 1
- Dubbel blinkning = Grupp 2

2. Lossa den GULA ledaren från +V DC och lägg kortvarigt på +V DC på ledaren för att byta grupper:

- Huvuden i samma grupp blinkar tillsammans.
- Huvuden i grupp 1 blinkar omväxlande med huvuden i grupp 2.

För blinkmönster:

Lägg kortvarigt på +V DC på den GULA ledaren:

- en gång för nästa mönster
- tre gånger i snabb följd för mönster 0

FP-Nr.	Blinkmönster:
1	Singel *
2	Dubbel *
3	Trippel *
4	fyrdubbla *
5	Fast

* Skall lampan användas inom Europa, är endast alternativen 1, 2, 3, och 4 tillåtna.



Elektrische aansluiting/opbouwmontage

- ROOD ←
Naar +VDC (zekering 3A)
- ZWART ←
Naar chassismassa
- GEEL ←
- WIT ←
low power / night mode (014.560-xxx)

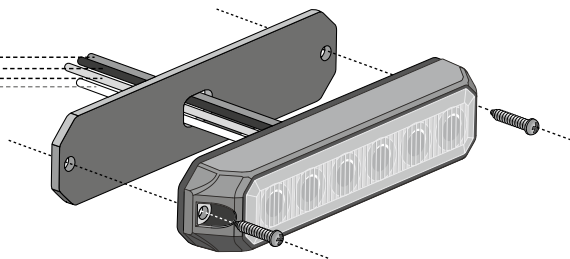

30

Voor synchronisatie:

Verbind GELE draden van alle koppen met elkaar voor synchronisatie (alle koppen moet op hetzelfde patroon zijn ingesteld)

Voor tegelijk of beurtelings knipperen:

1. Breng +VDC aan op RODE en GELE draden om groepeeringsmodus te activeren; lichtkop zal korte (enkele of dubbele) knippersignalen weergeven:

- Enkel knippersignaal = Groep 1
- Dubbel knippersignaal = Groep 2

2. Verwijder GELE draad van +VDC en verbind deze weer kort met +VDC om groepen te wijzigen:

- Koppen in dezelfde groep knipperen tegelijkertijd.
- Koppen van groep 1 knipperen beurtelings met koppen van groep 2.

Voor knipperpatronen:

Breng kort +VDC aan op GELE draad:

- een keer voor volgend patroon
- snel drie keer voor patroon 0

FP-Nr.	Blinkmuster:
1	Enkel *
2	Dubbel *
3	Drievoudig *
4	Viervoudig *
5	Stabiel

* Voor het gebruik van de lamp in Europa zijn alleen de knipperpatronen 1, 2, 3 en 4 toegestaan.



Conexión eléctrica / Montaje en superficie

- ROJO ←
A +VCC (fusible @ 3A)
- NEGRO ←
A la base de la estructura
- AMARILLO ←
- BLANCO ←
low power / night mode (014.560-xxx)

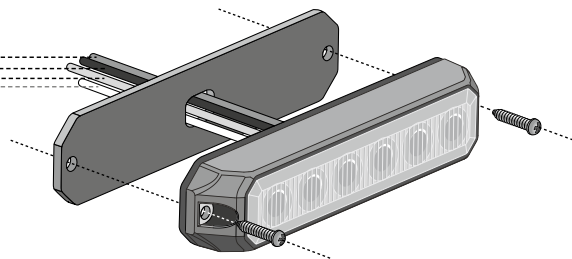

31

Para sincronización:

Conectar los cables AMARILLOS o todos los terminales juntos para la sincronización (todos los terminales deben seguir el mismo patrón)

Para destellos simultáneos o alternantes:

1. Aplicar +VCC a los cables ROJO y AMARILLO simultáneamente para introducir el modo de Agrupación; el piloto emitirá destellos cortos (únicos o dobles):

- Destello único = Grupo 1
- Destello doble = Grupo 2

2. Extraer el cable AMARILLO de +VDC y aplicar momentáneamente a +VCC para cambiar los grupos:

Los pilotos del grupo 1 se alternan con los pilotos del grupo 2 Heads.

Para patrones de destello:

Aplicar momentáneamente +VCC al cable AMARILLO:

- una vez para el patrón siguiente
- tres veces rápidamente para el patrón 0

FP-Nr.	Blinkmuster:
1	Único *
2	Doble *
3	Triple *
4	Cuádruple *
5	Constante

* Para el uso de las luces en la Unión Europea están autorizados sólo los patrones de destellos 1, 2, 3 y 4.



Collegamenti elettrici/montaggio superficiale

- ROSSO ←
A + V CC (fusibile a 3A)
- NERO ←
A massa telaio
- GIALLO ←
- BIANCO ←
low power / night mode (014.560-xxx)

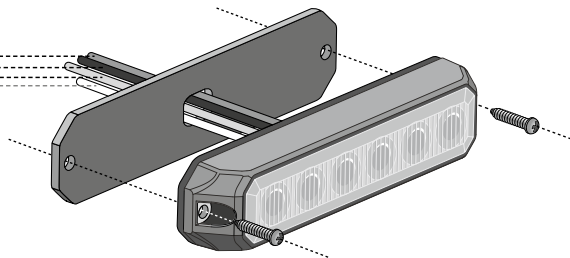

32

Per la sincronizzazione:
Collegare assieme i fili GIALLI di tutti i capi per la sincronizzazione (tutti i capi devono essere impostati secondo lo stesso pattern)

Per il lampeggiamento simultaneo e alternato:

1. Applicare + V CC ai fili ROSSI e GIALLI simultaneamente per inserire la modalità di raggruppamento;
la torcia mostrerà dei lampeggiamenti brevi (singoli o doppi)

- Lampeggiamento singolo = Gruppo 1
- Lampeggiamento doppio = Gruppo 2

2. Rimuovere i fili GIALLI da + v CC e applicare momentaneamente a + V CC per cambiare i gruppi:

- i capi dello stesso gruppo lampeggiano assieme
- i capi del Gruppo 1 si alternano con i capi del Gruppo 2

Per i pattern lampeggianti:

Applicare momentaneamente + VCC al filo GIALLO:

- una volta per il pattern successivo
- tre volte rapidamente per il pattern 0

FP-Nr.	Blinkmuster:
1	Singolo *
2	Doppio *
3	Triplo *
4	Quadruplo *
5	Fisso

* **Per il funzionamento del proiettore in ambito europeo sono ammessi solo i modelli di lampeggio 1, 2, 3 e 4.**



Sähköliitäntä / Pintakiinnitys

- PUNAINEN ←
kohteeseen +VDC (sulake @ 3A)
- MUSTA ←
runkomaahan
- KELTAINEN ←
- VALKOINEN ←
low power / night mode (014.560-xxx)

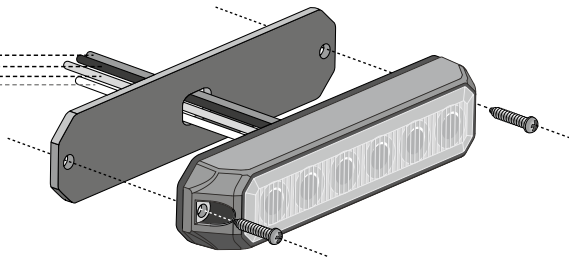

33

Synkronointia varten

Liitä kaikkien päiden KELTAISET johdot yhteen synkronointia varten (kaikki päät on asetettava samalla kuviolla).

Samanaikaista tai vuorottaista välähdystä varten

1. Liitä +VDC PUNAIISIIN ja KELTAISIIN johtoihin siirtyäksesi ryhmitystilaan.

Valopää näyttää lyhyttä (yksittäistä tai kaksinkertaista) välähdystä:

- Yksittäinen välähdys = Ryhmä 1
- Kaksinkertainen välähdys = Ryhmä 2

2. Irrota KELTAINEN johto +VDC:stä ja liitä se hetkellisesti +VDC:hen ryhmien vaihtamiseksi:

- Saman ryhmän päät välähtävät yhdessä
- Ryhmän 1 päät vuorottelevat ryhmän 2 päiden kanssa.

Välähdyskuviota varten:

Liitä +VDC hetkellisesti KELTAISEEN johtoon.

- kerran seuraavaa kuviota varten
- nopeasti kolme kertaa kuviota 0 varten

FP-Nr.	Blinkmuster:
1	Kaksinkertainen *
2	Nelinkertainen *
3	Kolmekertainen *
4	Nelinkertaistaa *
5	Yhtäjaksoinen

* Euroopassa valoa saa käyttää vain vilkkumalleilla 1, 2, 3 ja 4.

DE Beleuchtungsanlage auf einwandfreie Funktion hin prüfen

EN Check that the lighting system is working perfectly

FR Contrôler le bon fonctionnement de l'installation d'éclairage

SV Kontrollera att ljussystemet fungerar felfritt

NL Controleer of de verlichting goed functioneert

ES Comprobar que el sistema de iluminación funciona impecablemente

IT Controllare la perfetta funzionalità dell'impianto di illuminazione

FI Tarkasta valaistusjärjestelmän toiminta

Technische Daten
Technical Data
Caractéristiques techniques

Tekniska data
Technische gegevens
Datos técnicos

Dati tecnici
Tekniset tiedot





BST 6LED



012 160-801 (XB1)
012 160-851 (XA1) ---K1039
012 160-821 (XR1)
012 160-871

012 160-811 (XB1)
012 160-861 (XA1) ---K1039
012 160-831 (XR1)
012 160-881

35

<p>Typprüfung Type approval Homologation Typproving Typekeuring Formato de la homologación de tipo Omologazione Tyypihyväksyntä, muoto</p>	<p>Blue: -801/-811  2XD 012.160 BST 12V/24V P 13.8W XB1 E6 TOR 040471 65 000079</p> <p>Amber: -851/-861  2XD 012.160 BST 12V/24V P 9.6W XA1 E6 TOR 040471 65 000078</p> <p>Red: -821/-831  2XD 012.160 BST 12V/24V P 8W XR1 E6 TOR 040471 65 000094</p> <p>White: -871/-881  2XD 012.160 BST 12V/24V P 13.8W E6 TOR 040471</p>	<p>Max. Stromaufnahme Max. current consumption Intensité absorbée maximale Max. strömförbrukning Max. opgenomen stroom Consumo máximo de corriente Assorbimento max. di corrente Maks. virrankulutus</p>	<p>XB1 0.87A / 0.58A XA1 0.78A / 0.40A XR1 0.80A / 0.40A weiss/white 1.15A / 0.58A</p>
<p>Betriebsspannung Operating voltage Tension de service Driftspänning Bedrijfsspanning Tensión de servicio Tensione di esercizio Käyttöjännite</p>	<p>11 – 30 VDC</p>	<p>Leistungsaufnahme Power consumption Puissance absorbée Eff ektförbrukning Vermogensopname Consumo de potencia Potenza assorbita Tehonotto</p>	<p>XB1 13.8W XA1 9.6 W XR1 8.0W weiss/white 13.8W</p>

Technische Daten
Technical Data
Caractéristiques techniques

Tekniska data
Technische gegevens
Datos técnicos

Dati tecnici
Tekniset tiedot



BST 6LED



012 160-901 (XB1)
012 160-951 (XA1) ---K1129
012 160-971

012 160-911 (XB1)
012 160-961 (XA1) ---K1129
012 160-981

36

<p>Typprüfung Type approval Homologation Typproving Typekeuring Formato de la homologación de tipo Omologazione Tyypihyväksyntä, muoto</p>	<p>Blue: -901/-911  2XD 012.160 BST-V 12V/24V P 13.8W XB1 E6 TOR 040471 65 000101 Amber: -951/-961  2XD 012.160 BST-V 12V/24V P 9.6W XA1 E6 TOR 040471 65 000100 White: -971/-981  2XD 012.160 BST-V 12V/24V P 13.8W E6 TOR 040471</p>	<p>Max. Stromaufnahme Max. current consumption Intensité absorbée maximale Max. strömförbrukning Max. opgenomen stroom Consumo máximo de corriente Assorbimento max. di corrente Maks. virrankulutus</p>	<p>XB1 0.87A / 0.58A XA1 0.78A / 0.40A weiss/white 1.15A / 0.58A</p>
<p>Betriebsspannung Operating voltage Tension de service Driftspänning Bedrijfsspanning Tensión de servicio Tensione di esercizio Käyttöjännite</p>	<p>11 – 30 VDC</p>	<p>Leistungsaufnahme Power consumption Puissance absorbée Eff ektförbrukning Vermogensopname Consumo de potencia Potenza assorbita Tehonotto</p>	<p>XB1 13.8W XA1 9.6 W weiss/white 13.8W</p>

Technische Daten
Technical Data
Caractéristiques techniques

Tekniska data
Technische gegevens
Datos técnicos









Dati tecnici
Tekniset tiedot

BST 3LED

014.561-001 (XB1)
014.561-101 (XB1)
014.561-201 (XA1) ---K1558
014.561-401 (XA1) ---K1558

014.561-601 (XR1)
014.561-701 (XR1)
014.561-801
014.561-901

37

<p>Typprüfung Type approval Homologation Typprovnig Typekeuring Formato de la homologación de tipo Omologazione Tyyppihyväksyntä, muoto</p>	<p>BST 3LED / Amber: -201/-401  2XD 014.561 BST 12V/24V P 8.1W XA1  TOR 040586 / 65 000120</p> <p>BST 3LED / Blue: -001/-101  2XD 014.561 BST 12V/24V P 8.1W XB1  TOR 040586 / 65 000121</p> <p>BST 3LED / Red: -601/-701  2XD 014.561 BST 12V/24V P 6.1W XR1  TOR 040586 / 65 000226</p> <p>BST 3LED / White: -801/-901  2XD 014.561 BST 12V/24V P 8.1W  TOR 040586</p>	<p>Max. Stromaufnahme Max. current consumption Intensité absorbée maximale Max. strömförbrukning Max. opgenomen stroom Consumo máximo de corriente Assorbimento max. di corrente Maks. virrankulutus</p>	<p>XB1 0.68A / 0.34A XA1 0.68A / 0.34A XR1 0.51A / 0.26A weiss/white 0.68A / 0.34A</p>
<p>Betriebsspannung Operating voltage Tension de service Driftspänning Bedrijfsspanning Tensión de servicio Tensione di esercizio Käyttöjännite</p>	<p>11 – 30 VDC</p>	<p>Leistungsaufnahme Power consumption Puissance absorbée Eff ektförbrukning Vermogensopname Consumo de potencia Potenza assorbita Tehonotto</p>	<p>XB1 8.1W XA1 8.1 W XR1 6.1W weiss/white 8.1W</p>

Technische Daten
Technical Data
Caractéristiques techniques



Tekniska data
Technische gegevens
Datos técnicos

Dati tecnici
Tekniset tiedot

BST 6LED class 2

014.560-001 (XB2)
014.560-101 (XB2)
014.560-201 (XA2) ---K1557
014.560-401 (XA2) ---K1557

38

<p>Typprüfung Type approval Homologation Typproving Typekeuring Formato de la homologación de tipo Omologazione Tyyppihyväksyntä, muoto</p>	<p>BST 6LED class 2 / Amber: -201/-401  2XD 014.560 BST XA2 E6 TOR 050944 12V/24V P 13.1W 65 000118</p> <p>BST 6LED class 2 / Blue: -001/-101  2XD 014.560 BST XB2 E6 TOR 050944 12V/24V P 13.1W 65 000119</p>	<p>Max. Stromaufnahme Max. current consumption Intensité absorbée maximale Max. strömförbrukning Max. opgenomen stroom Consumo máximo de corriente Assorbimento max. di corrente Maks. virrankulutus</p>	<p>XB2 1.1A / 0.55A</p> <p>XA2 1.1A / 0.55A</p>
<p>Betriebsspannung Operating voltage Tension de service Driftspänning Bedrijfsspanning Tensión de servicio Tensione di esercizio Käyttöjännite</p>	<p>11 – 30 VDC</p>	<p>Leistungsaufnahme Power consumption Puissance absorbée Eff ektförbrukning Vermogensopname Consumo de potencia Potenza assorbita Tehonotto</p>	<p>XB2 13.1W</p> <p>XA2 13.1W</p>



HELLA GmbH & Co. KGaA

Rixbecker Straße 75

59552 Lippstadt / Germany

www.hella.com

© HELLA GmbH & Co. KGaA,

Lippstadt

460 909-26 / 01.25

Printed in Germany