

DER STARKE KOMPAKTE

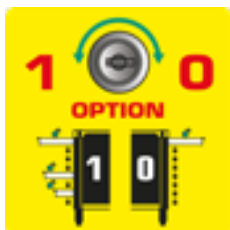

Werkstattwagen P15
mit 8 Schubladen
873.1008



DUO Lock geniale Verschlusstechnik



8 Schubladen jeweils bis zu 50 kg belastbar



Stabiles **Kugellager**



Kunststoffoberfläche



Schloss abschließbar

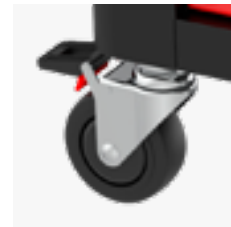

Antistatische Rollen mit Bremse



Integrierter **Kantenschutz**

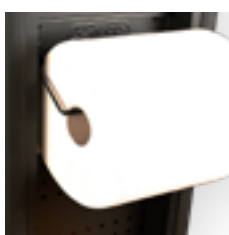

Inklusive **Papierrollenhalter**



Inklusive **Dosenhalter**

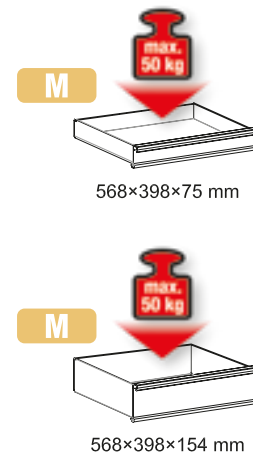
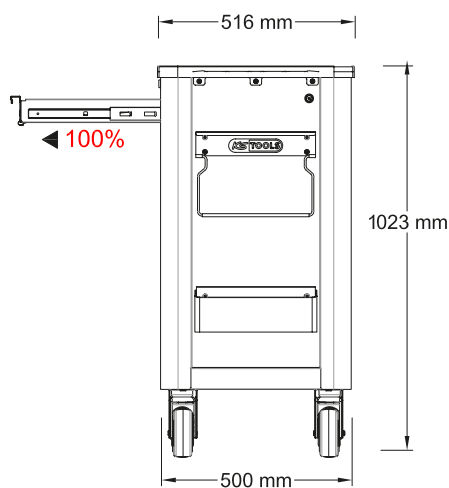
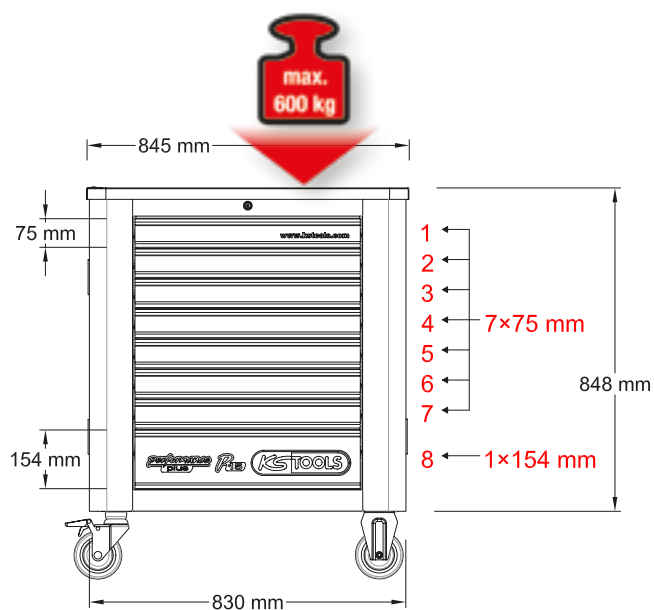

P15

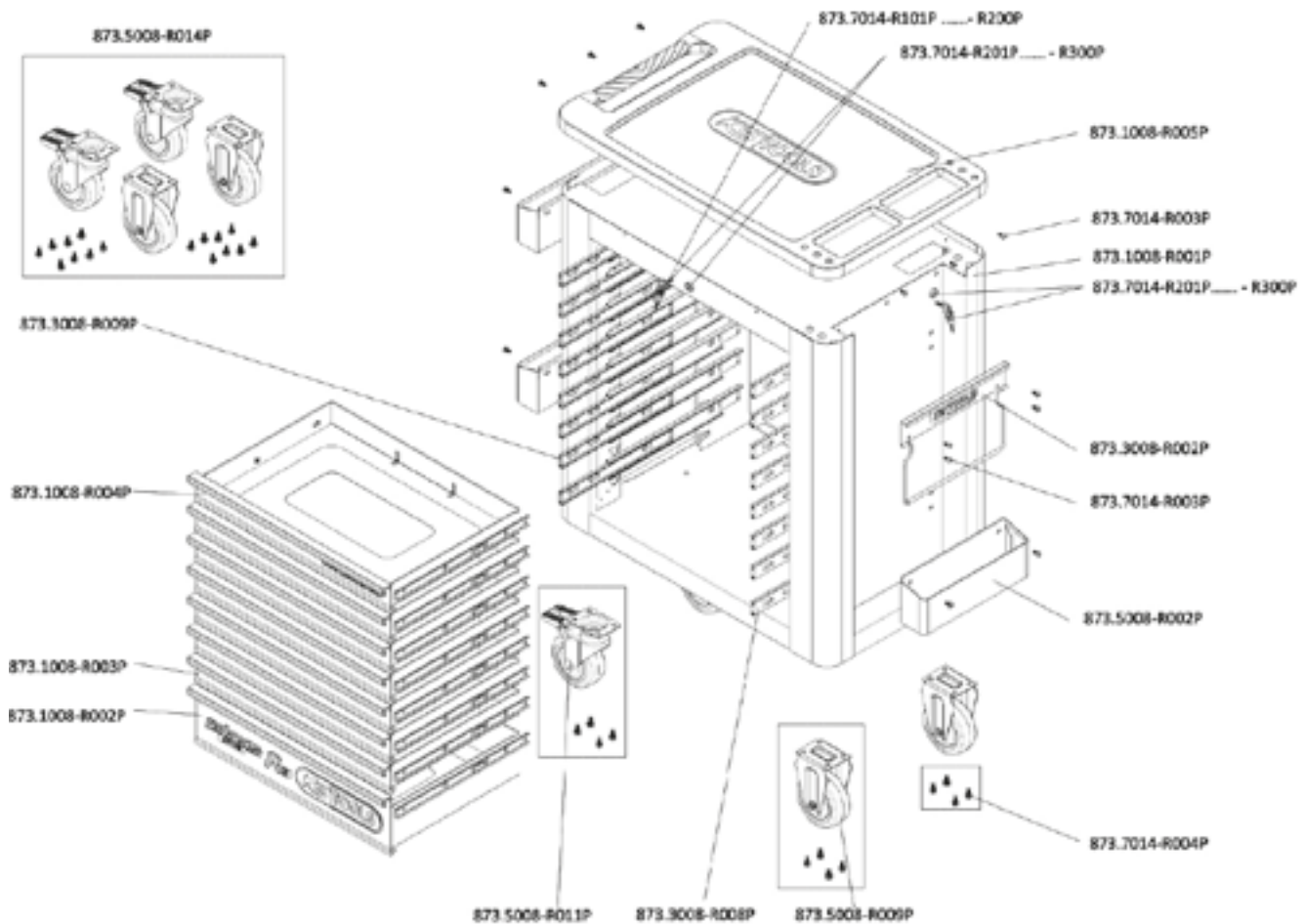

EINZELTEIL-LISTE

Art.-Nr.	Beschreibung	Menge
873.7014-R101P...	Ersatzschlüssel für Schloß Nummer xyz zu PERFORMANCEplus Werkstattwagen	2
873.7014-R201P...	Schloß mit 2 Schlüsseln zu PERFORMANCEplus Werkstattwagen Schloß-Nr. xyz	2
873.1008-R001P	Korpus zu Werkstattwagen P15	1
873.1008-R002P	Schublade mit Logo und Kugelführung zu Werkstattwagen P15, 568x398x145 mm	1
873.1008-R003P	Schublade mit Kugelführung zu Werkstattwagen P10/P10TC/P15, 568x398x65 mm	6
873.1008-R004P	Schublade mit Website und Kugelführung zu Werkstattwagen P10/P15, 568x398x65 mm	1
873.1008-R005P	Kunststoff Arbeitsplatte mit Handgriff zu Werkstattwagen P15	1
873.3008-R002P	Papierrollen-Halter zu PERFORMANCEplus Werkstattwagen P10/P15/P25	1
873.3008-R008P	Vollauszug Kugelführung mit autom. Rückzug	8
873.3008-R009P	Vollauszug Kugelführung mit autom. Rückzug	8
873.5008-R002P	Dosen-Halter zu PERFORMANCEplus Werkstattwagen P10/P15/P25/P35	3
873.5008-R009P	Laufrolle starr für PERFORMANCEplus Werkstattwagen inkl. Schrauben	2
873.5008-R011P	Lenkrolle mit Bremse zu PERFORMANCEplus Werkstattwagen inkl. Schrauben	2
873.5008-R014P	Rollen-Satz zu PERFORMANCEplus Werkstattwagen inkl. Schrauben	1
873.7014-R003P	Schraube M6x12 für PERFORMANCEplus Werkstattwagen-Zubehör	16
873.7014-R004P	Schraube M8 für Rollen zu PERFORMANCEplus Werkstattwagen (16 Stück)	1



873.7014-R101P...R200P
Ersatzschlüssel für Schlossnummer xyz



873.7014-R201P...R300P
Schloss inklusive 2 Schlüssel, Schlossnummer xyz



873.3008-R008P
Laufschiene mit Selbsteinzug, für Schublade, rechts



873.3008-R009P
Laufschiene mit Selbsteinzug, für Schublade, links



873.5008-R009P
Laufrolle, starr, inklusive Schrauben



873.5008-R011P
Lenkrolle mit Feststellbremse inklusive Schrauben



873.5008-R014P
Rollensatz, 2 x Lenkrolle + 2 x Laufrolle, inklusive Schrauben



873.1008-R005P
Kunststoff-Arbeitsplatte mit Griff



873.1008-R004P
Schublade mit Website, inklusive Laufschiene, H=65 mm, B=568 mm x T=398 mm



873.1008-R003P
Schublade, inklusive Laufschiene, H=65 mm, B=568 mm x T=398 mm



873.1008-R002P
Schublade mit Logo, inklusive Laufschiene, H=145 mm, B=568 mm x T=398 mm



873.5008-R002P
Dosenhalter inklusive Schrauben, B = 310 mm



873.3008-R002P
Papirollenhalter inklusive Schrauben, B = 320 mm



873.7014-R004P
Schraube, M8, mit Unterlegscheibe, 16 Stück



873.7014-R003P
Schraube, M6 x 12 mm, 1 Stück



873.1008-R001P
Stahlkorpus



Unersetzlich ist nur die Qualität!

JEDER WAGEN EIN UNIKAT

**Werkzeugaufnahmen, Rohrhalter, Ablageböden,
Magnetschalen, Klemmen, Halter und Haken:
Das umfangreiche Zubehörprogramm von
Performance Plus lässt keine Wünsche offen und
macht Ihren Werkstattwagen zu Ihrem persön-
lichen Unikat. Erweitern Sie Ihre Performance!**

**FREI KONFIGURIERBAR –
AUCH NACH DEM KAUF**

**Komplett auf Ihre Bedürfnisse
abgestimmt**

**AUFNAHMEN FÜR ALLE
WERKZEUGARTEN**

ZUBEHÖR

- passend für Lochmaß 10 x 10 mm – Lochabstand 38 mm
- inklusive Fixierschraube
- Grundplattenstärke 1,5 mm
- verzinkt
- Stahlblech



860.0855
Rohrhalter, Ø 60 mm
paarweise zu benutzen



860.0856
Rohrhalter, Ø 100 mm



860.0857
Ablageboden ohne Einteilung,
350 x 125 mm



860.0858
Ablageboden ohne Einteilung,
450 x 150 mm



860.0859
Lagersichtkastenhalter einfach, für
Größe 7 und 8



860.0870
Universal-Werkzeugaufnahme,
390 x 45mm



860.0871
Universal-Werkzeugaufnahmebox,
55 x 310 x 125mm mit Holzplatte
zum Selbstbohren

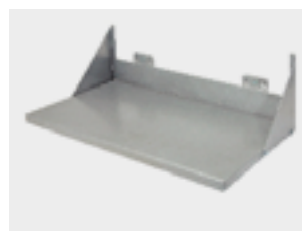

860.0878
Stahlblechablage, 435 x 250 mm



860.0873
Stecknusshalter, 9 Löcher,
390 x 30mm



860.0879
Papierrollenhalter, 355 mm



860.0880
Prospekthalter, 220 x 310 mm



860.0881 Zeichnungshalter,
220 x 310 mm



860.0886
Werkzeughalter für MK-2 und MK-3,
16 Löcher



860.0882 Magnet-Set, Ø 25 mm, rot, 10er Pack verschiedene Farben, ideal einsetzbar für Metall Oberflächen, Magnet kunststoffummantelt



860.0883 Magnet-Set, Ø 25 mm, grün, 10er Pack, verschiedene Farben, ideal einsetzbar für Metall Oberflächen, Magnet kunststoffummantelt



860.0884 Magnet-Set, Ø 25 mm, blau, 10er Pack, verschiedene Farben, ideal einsetzbar für Metall Oberflächen, Magnet kunststoffummantelt



860.0887 Bithalter, 7 Löcher, 150 x 35mm



860.0872 Innerechskanthalter, 11 Löcher, 145 x 70mm



860.0894 Stecknuss-Halter für 1/2" Stecknüsse, 6 Löcher



860.0895 Stecknuss-Halter für 1/2" Stecknüsse, 13 Löcher



860.0801 Werkzeughalter mit geradem Dorn Ø 6 mm, 50 mm



860.0802 Werkzeughalter mit geradem Dorn Ø 6 mm, 100 mm



860.0803 Werkzeughalter mit geradem Dorn Ø 6 mm, 150 mm



860.0820 Doppelter Werkzeughalter mit geradem Dorn Ø 6mm, 35 mm



860.0821 Doppelter Werkzeughalter mit geradem Dorn Ø 6 mm, 50 mm



860.0822 Doppelter Werkzeughalter mit geradem Dorn Ø 6 mm, 75 mm



860.0804 Werkzeughalter mit schrägem Hakenende Ø 6 mm, 50 mm



860.0805 Werkzeughalter mit schrägem Hakenende Ø 6 mm, 100 mm



860.0806 Werkzeughalter mit schrägem Hakenende Ø 6 mm, 150 mm



860.0807 Werkzeughalter mit schrägem Hakenende Ø 6 mm, 200 mm



860.0812 Doppelter Werkzeughalter mit schrägem Hakenende, Ø 6 mm, 35 mm



860.0813 Doppelter Werkzeughalter mit schrägem Hakenende, Ø 6 mm, 50 mm



860.0814 Doppelter Werkzeughalter mit schrägem Hakenende, Ø 6 mm, 75 mm



860.0815 Doppelter Werkzeughalter mit schrägem Hakenende, Ø 6 mm, 150 mm



860.0809 Werkzeughalter mit senkrechtem Hakenende Ø 6 mm, 35 mm



860.0810 Werkzeughalter mit senkrechtem Hakenende Ø 6 mm, 75 mm



860.0811 Werkzeughalter mit senkrechtem Hakenende Ø 6 mm, 125 mm



860.0816
Doppelter Werkzeughalter mit
senkrechtem Hakenende, Ø 6 mm,
35 mm



860.0817
Doppelter Werkzeughalter mit
senkrechtem Hakenende, Ø 6 mm,
50 mm

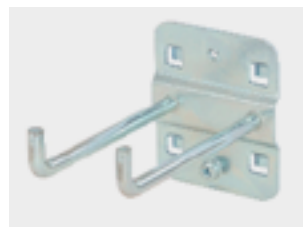

860.0818
Doppelter Werkzeughalter mit
senkrechtem Hakenende, Ø 6 mm,
75 mm

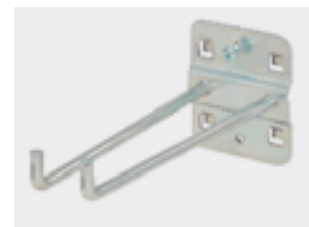

860.0819
Doppelter Werkzeughalter mit
senkrechtem Hakenende, Ø 6 mm,
150 mm



860.0824
Werkzeugklemme einfach-klein,
Ø 6 mm



860.0825
Werkzeugklemme einfach-klein,
Ø 10 mm



860.0826
Werkzeugklemme einfach-klein,
Ø 13 mm



860.0827
Werkzeugklemme einfach-klein,
Ø 16 mm



860.0828
Werkzeugklemme einfach-klein,
Ø 19 mm



860.0829
Werkzeugklemme doppelt-klein,
Ø 6 mm



860.0830
Werkzeugklemme doppelt-klein,
Ø 10 mm



860.0831
Werkzeugklemme doppelt-klein,
Ø 13 mm



860.0832
Werkzeugklemme doppelt-klein,
Ø 16 mm



860.0833
Werkzeugklemme doppelt-klein,
Ø 19 mm



860.0834
Werkzeugklemme einfach-groß,
25 mm



860.0835
Werkzeugklemme einfach-groß,
28 mm

ZUBEHÖR



860.0836
Werkzeugklemme einfach-groß,
32 mm

2,90
EUR



860.0823
Schräghaken für Nüsse und Steck-
schlüssel Ø 6 mm

1,90
EUR



860.0837
Zangenhalter-Tiefe 20mm, 35 mm

2,50
EUR



860.0838
Zangenhalter-Tiefe 20mm, 55 mm

2,50
EUR



860.0839
Zangenhalter-Tiefe 20mm, 75 mm

3,50
EUR



860.0840
Rundhalter, 25 x 65 mm

2,90
EUR



860.0841
Maschinenhalter, Ø 40 mm

2,90
EUR



860.0842
Maschinenhalter, Ø 60 mm

3,50
EUR



860.0843
Maschinenhalter, Ø 80 mm

3,90
EUR



860.0844
Werkzeughalter-3-fach, Ø 6 mm,
150 mm

3,50
EUR



860.0874
Kabelhalter, 150 mm

4,90
EUR



860.0875
Kabelhalter, 200 mm

4,90
EUR



860.0876
Werkzeughalter für
SB-Verpackungen, 125 mm

3,50
EUR



860.0877
Werkzeughalter für
SB-Verpackungen, 150 mm

3,90
EUR

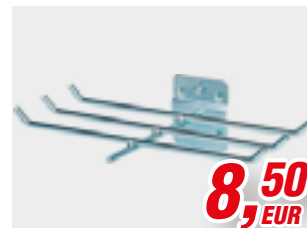

860.0845
Sechsfach Werkzeughalter-
Hakenenden, 45° abgewinkelt

8,50
EUR



860.0860
Grundplatten, klein

1,90
EUR



860.0861
Grundplatten, groß

2,50
EUR



860.0862
Lagersichtskastenhalter,
550 x 40mm

14,90
EUR



860.0863
Lagersichtskastenhalter,
550 x 60mm

17,90
EUR



860.0864
Schraubenschlüsselhalter für 10
Schlüssel, 145 mm

12,90
EUR



860.0865
Schraubenschlüsselhalter für 10
Schlüssel, 225 mm

17,90
EUR



860.0866
Runddosenhalter Ø 70 mm, 100 mm

9,50
EUR

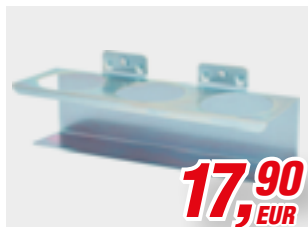

860.0867
Runddosenhalter Ø 70 mm, 300 mm

17,90
EUR



860.0868
Schlauchhalter, 230 x 70mm

14,90
EUR

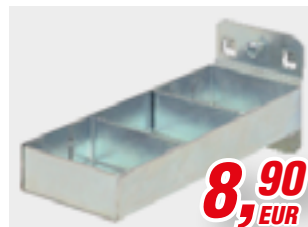

860.0847
Kleinteileablage mit Einteilung,
150 x 55 mm

8,90
EUR



860.0848
Kleinteileablage ohne Einteilung,
150 x 55 mm

8,90
EUR



860.0869
Universal-Werkzeugaufnahme,
120 x 70mm mit Kunststoffklotz zum
Selbstbohren

12,90
EUR



860.0846
Kombinationshalter, 150 x 55 mm

3,90
EUR



860.0849
Schraubenschlüsselhalter-waage-
recht, 8 Löcher

8,90
EUR



860.0850
Schraubendreherhalter, 6 Löcher,
150 x 55mm

7,90
EUR



860.0851
Schraubendreherhalter, 12 Löcher,
150 x 55mm

14,90
EUR



860.0852
Bohrer- und Innensechskanthalter,
14 Löcher

9,50
EUR



860.0853
Bohrer- und Innensechskanthalter,
28 Löcher

19,90
EUR



860.0854
Sägenhalter, 4 Löcher, 150 mm
paarweise zu benutzen

4,50
EUR

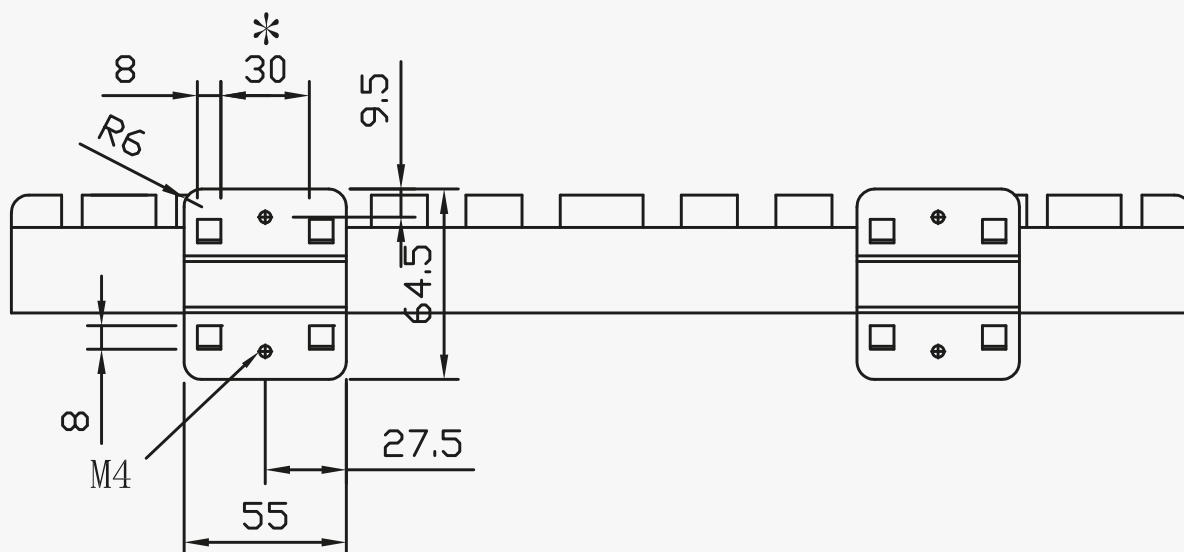

BRINGEN SIE IHREN SCHATZ UNTER DIE HAUBE

Wer mit Performance Plus arbeitet, der möchte vermutlich nicht so schnell Feierabend machen. Wenn es dann aber doch so weit ist, können Sie Ihren Werkstattwagen mit der passenden Haube vor Staub und Kratzern schützen.



P15



873.0015
Abdeckhaube zu Werkstattwagen
P15, 880x550x860 mm