



Betriebsanleitung
Operating Instructions
Mode d'emploi



Instrucciones de uso
Gebruiksaanwijzing
Instruzioni d'uso



V4813





V4813

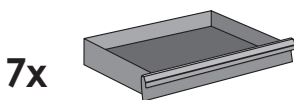
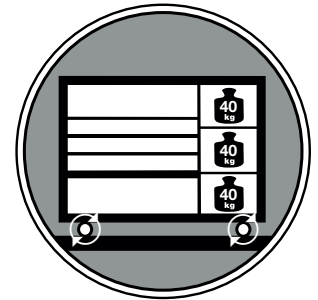
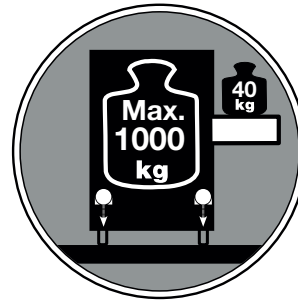
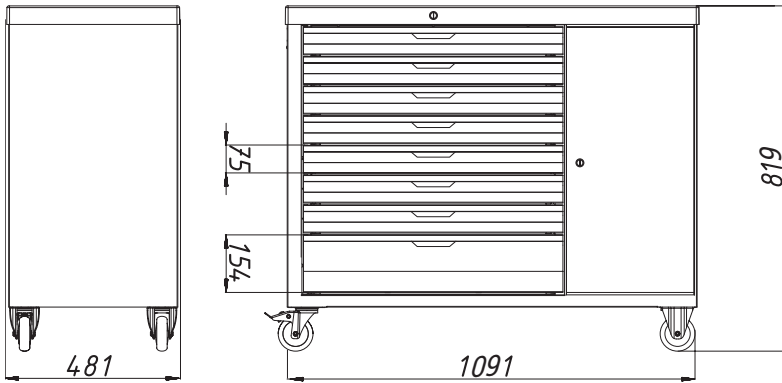

569 x 398 x 75 mm

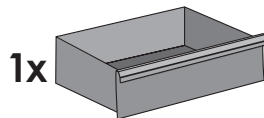

569 x 398 x 154 mm

	Zubehör	Accessories
V2393	Dosenhalter	Can holder
V2397	Papierrollenhalter	Holder for paper reel
V2398	Trennblech-Satz	Set separation sheets
V4893	Fahrgriff	Handle

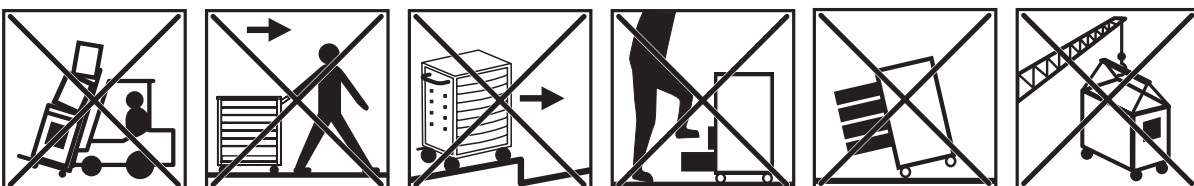
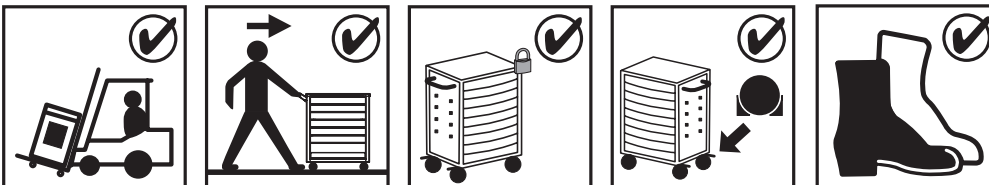

VIGOR GmbH • Am Langen Siepen 13-15 • 42857 Remscheid • GERMANY

+49 (0) 21 91 / 97 95 • FAX +49 (0) 21 91 / 97 96 00 • e-mail info@vigor-equipment.com • www.vigor-equipment.com