



Betriebsanleitung

Werkstattwagen ViGOR 1000XL
Edelstahl- Ausführung



Operating Instructions

Tool Trolley ViGOR 1000 XL
stainless model

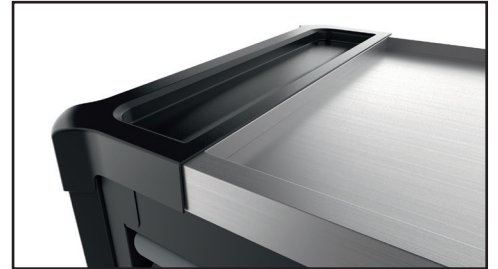

V4481-X BA



Technische Daten / Technical data:



V4481-X

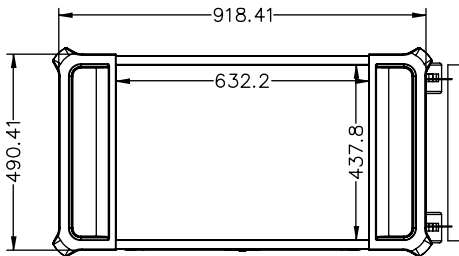
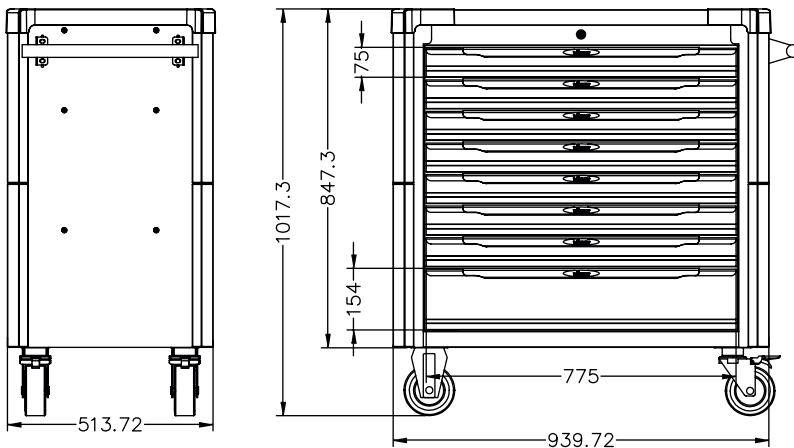

	Einzel- und Ersatzteile	Spare Parts
V1907	Bockrolle Ø 125 mm	Fixed Castor Ø 125 mm
V1908	Lenkrolle mit Bremse Ø 125 mm	Swivel Castor with brake Ø 125 mm
V1903	Führungsschienen	Drawer Rails (Pair)
V4111	Hohes Schubfach	High Drawer
V4112	Flaches Schubfach	Flat Drawer
V1904	Verriegelungssystem	Locking System
Zubehör:		Accessories
V2393-S	Dosenhalter	Can Holder
V2398	Trennblech-Satz	Set separation sheets
V4481-1	Trennblech-Satz	Set separation sheets
V6221	Laptop-Ablage	Laptop table

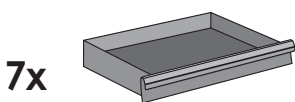
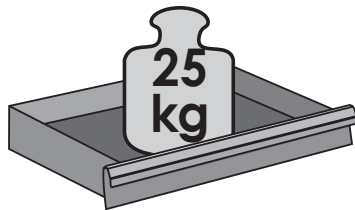

774 x 398 x 75 mm

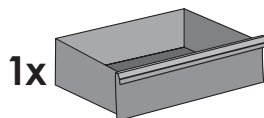

774 x 398 x 154 mm

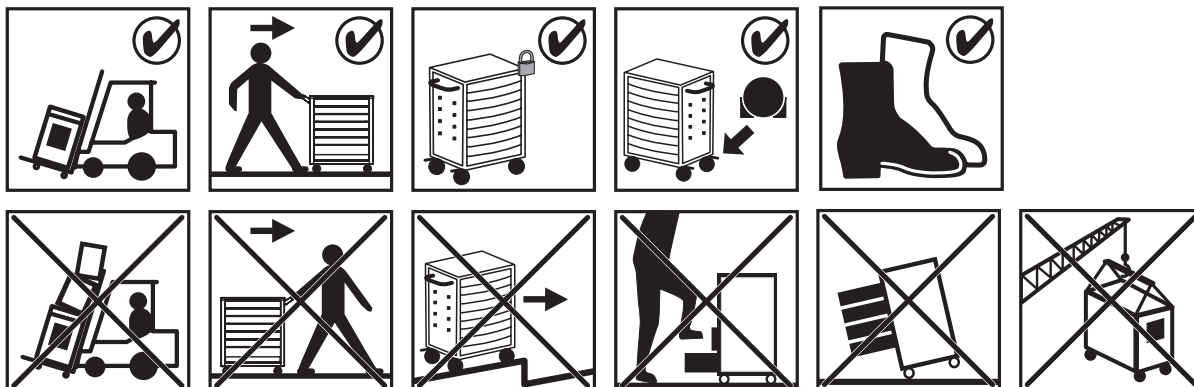

ViGOR GmbH • Am Langen Siepen 13-15 • 42857 Remscheid • GERMANY

+49 (0) 21 91 / 97 95 • FAX +49 (0) 21 91 / 97 96 00 • e-mail info@vigor-equipment.com • www.vigor-equipment.com