

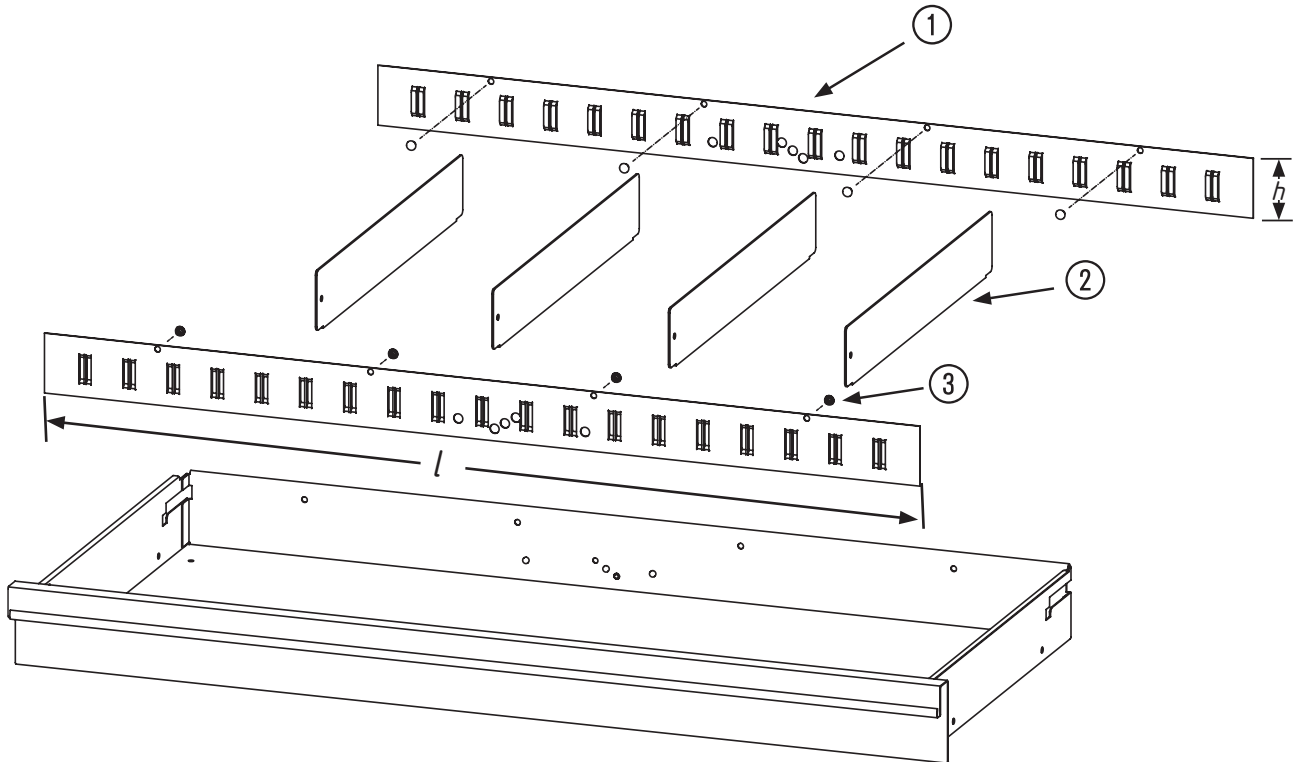















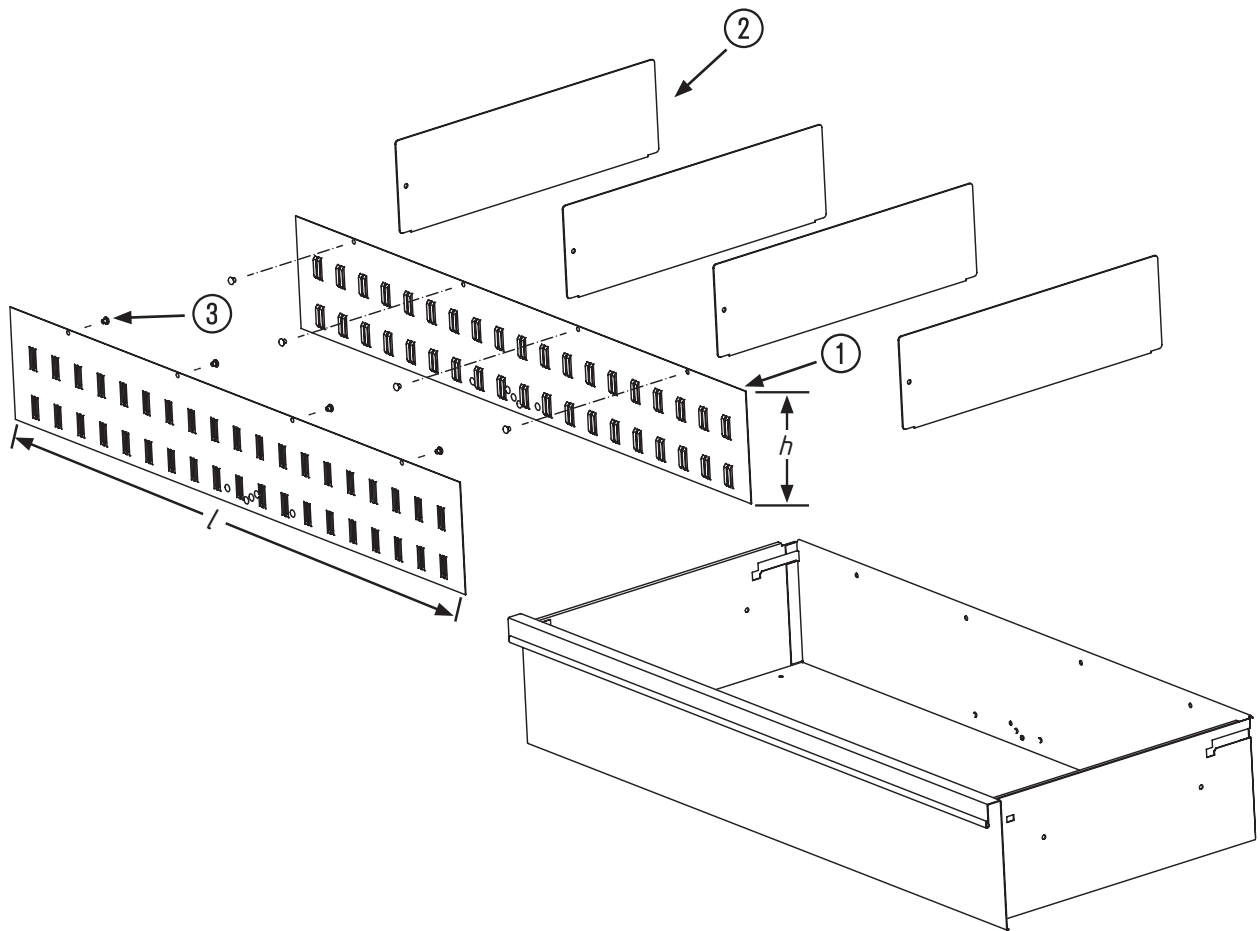

# 176 N / 179 N Trennbleche



<b>HAZET</b> No.			$\longleftrightarrow l \longleftrightarrow$	$\longleftrightarrow h \longleftrightarrow$	
161 T-176 N/4	4	①	516 mm	58 mm	2
		②			2
		③			4
161 T-179 N/4	4	①	516 mm	58 mm	2
		②			2
		③			4
161 T-179 N XL/5	5	①	688 mm	58 mm	2
		②			3
		③			4
161 T-179 N XXL/6	6	①	863 mm	58 mm	2
		②			4
		③			8
161 T-395x60/5	5	②			5
161 T-179 N XXLD/6	6	①	863 mm	58 mm	2
		②			4
		③			8



<b>HAZET</b> No.			$\longleftrightarrow l \longleftrightarrow$	$\longleftrightarrow h \longleftrightarrow$	
161 T-176 N/4H	4	①	516 mm	143 mm	2
		②			2
		③			4
161 T-179 N/4H	4	①	516 mm	143 mm	2
		②			2
		③			4
161 T-179 NXL/5H	5	①	688 mm	143 mm	2
		②			3
		③			4
161 T-179 NXXL/6H	6	①	863 mm	143 mm	2
		②			4
		③			8
161 T-395x120/5	5	②			5
161 T-179 NXXLD/6H	6	①	863 mm	143 mm	2
		②			4
		③			8

**HAZET - WERK** Hermann Zerver GmbH & Co. KG  
 Güldenwerther Bahnhofstraße 25 - 29 • 42857 Remscheid • GERMANY  
 +49 (0) 21 91 / 7 92-0 • [www.hazet.de](http://www.hazet.de) •  [info@hazet.de](mailto:info@hazet.de)