

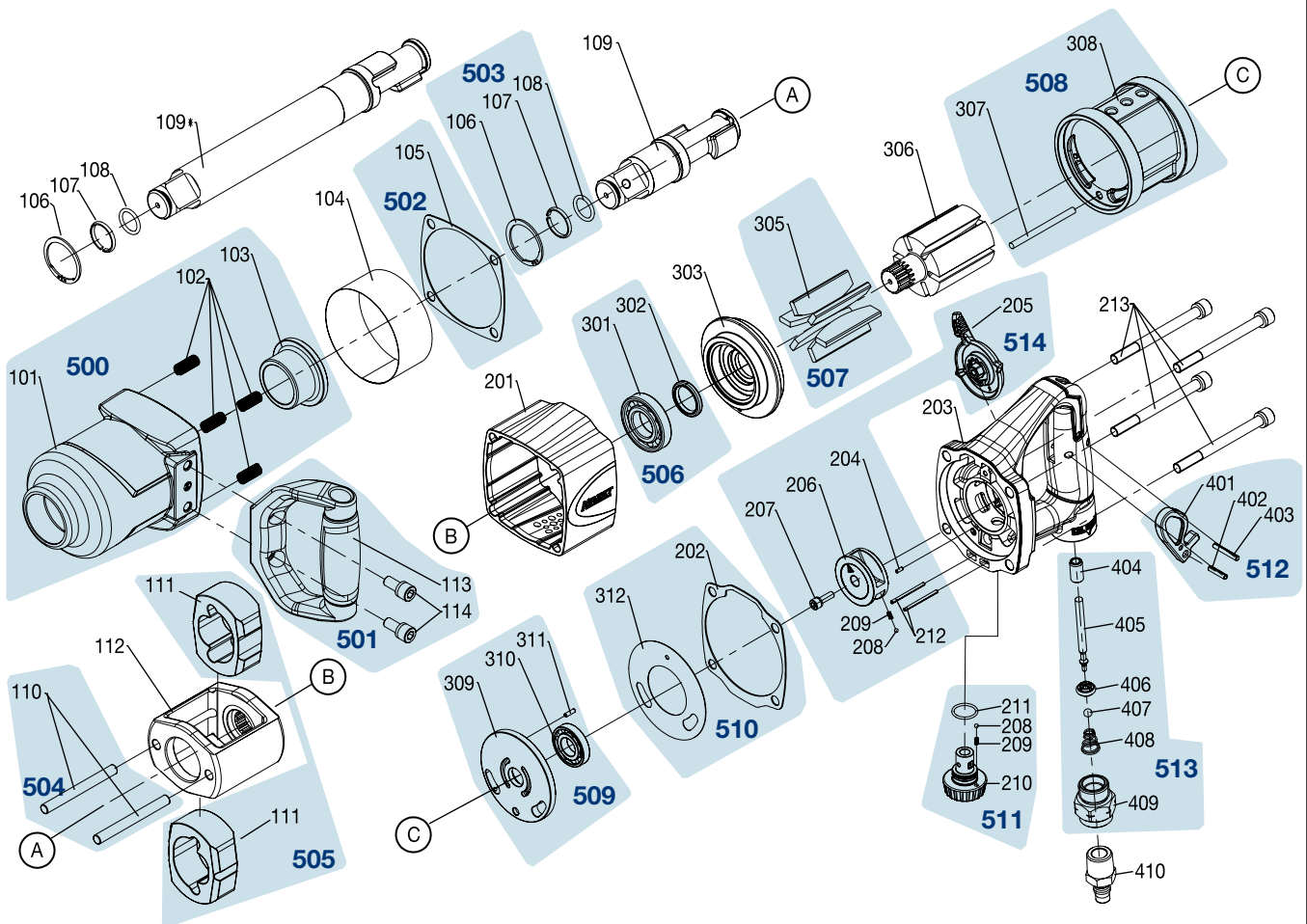





Ersatzteile 9014 MG-1, -2 **HAZET**









	HAZET No.	Bezeichnung	Designation	Désignation	
109	9014 MG-1-01	Vierkant 9014 MG-1	Anvil 9014 MG-1	Carré de recharge 9014 MG-1	1
109*	9014 MG-2-01	Vierkant 9014 MG-2	Anvil 9014 MG-2	Carré de recharge 9014 MG-2	1
112	9014 MG-01	Schlagwerkgehäuse	Hammer mechanism housing	Boîtier de mécanisme de frappe	1
201	9014 MG-02	Gehäuse	Housing	Boîtier	1
203	9014 MG-021	Hintere Gehäuseabdeckung	Rear cover unit	Capot de boîtier arrière	1
303	9014 MG-022	Vordere Endplatte	Front End Plate	Plaque d'extrémité avant	1
306	9014 MG-05	Rotor	Rotor	Rotor	1
500	9014 MG-06/6	Vorderes Gehäuse	Front Housing	Boîtier avant	6
		Inhalt: 101, 102 (4x), 103	Contents: 101, 102 (4x), 103	Contenu : 101, 102 (4x), 103	
501	9014 MG-07/3	Handgriff	Handle	Poignée	3
		Inhalt: 113, 114 (2x)	Contents: 113, 114 (2x)	Contenu : 113, 114 (2x)	
502	9014 MG-08/5	Vordere Gehäusedichtung	Front Housing Gasket	Point de boîtier avant	5
		Inhalt: 105 (5)	Contents: 105 (5)	Contenu : 105 (5)	

	HAZET No.	Bezeichnung	Designation	Désignation	
503	9014 MG-09/3	Ring Satz	<i>Ring Set</i>	<i>Jeu d'anneaux</i>	3
		Inhalt: 106, 107, 108	<i>Contents: 106, 107, 108</i>	<i>Contenu : 106, 107, 108</i>	
504	9014 MG-10/2	Stift	<i>Pin</i>	<i>Goupille</i>	2
		Inhalt: 110 (2x)	<i>Contents: 110 (2x)</i>	<i>Contenu : 110 (2x)</i>	
505	9014 MG-11/2	Hammer-Satz	<i>Hammer Set</i>	<i>Jeu de marteaux</i>	2
		Inhalt: 111 (2x)	<i>Contents: 111 (2x)</i>	<i>Contenu : 111 (2x)</i>	
506	9014 MG-12/2	Vorderes Lager	<i>Front Bearing</i>	<i>Palier avant</i>	2
		Inhalt: 301, 302	<i>Contents: 301, 302</i>	<i>Contenu : 301, 302</i>	
507	9014 MG-13/6	Lamellen	<i>Rotor Blades</i>	<i>Lamelles</i>	6
		Inhalt: 305 (6)	<i>Contents: 305 (6)</i>	<i>Contenu : 305 (6)</i>	
508	9014 MG-14/2	Zylinder	<i>Cylinder</i>	<i>Vérin</i>	2
		Inhalt: 307, 308	<i>Contents: 307, 308</i>	<i>Contenu : 307, 308</i>	
509	9014 MG-15/3	Hintere Endplatte	<i>Rear End Plate</i>	<i>Plaque d'extrémité arrière</i>	3
		Inhalt: 309, 310, 311	<i>Contents: 309, 310, 311</i>	<i>Contenu : 309, 310, 311</i>	
510	9014 MG-16/10	Dichtungs-Satz	<i>Gasket Set</i>	<i>Jeu de joints</i>	10
		Inhalt: 202 (5x), 312 (5x)	<i>Contents: 202 (5x), 312 (5x)</i>	<i>Contenu : 202 (x5), 312 (5x)</i>	
511	9014 MG-17/4	Regulator	<i>Regulator</i>	<i>Régulateur d'air</i>	4
		Inhalt: 208, 209, 210, 211	<i>Contents: 208, 209, 210, 211</i>	<i>Contenu : 208, 209, 210, 211</i>	
512	9014 MG-18/3	Abzugshebel	<i>Trigger unit</i>	<i>Levier de tirage</i>	3
		Inhalt: 401, 402, 403	<i>Contents: 401, 402, 403</i>	<i>Contenu : 401, 402, 403</i>	
513	9014 MG-19/6	Luft einlass	<i>Air inlet</i>	<i>Admission d'air</i>	6
		Inhalt: 404, 405, 406, 407, 408, 409	<i>Contents: 404, 405, 406, 407, 408, 409</i>	<i>Contenu : 404, 405, 406, 407, 408, 409</i>	
514	9014 MG-20/8	Umschalter	<i>Lever Set</i>	<i>Jeu d'anneaux</i>	8
		Inhalt: 204, 205, 206, 207, 208, 209, 212 (2x)	<i>Contents: 204, 205, 206, 207, 208, 209, 212 (2x)</i>	<i>Contenu : 204, 205, 206, 207, 208, 209, 212 (2x)</i>	

Positionen, die keine **HAZET** Material-No. haben, sind nur über den HAZET-Service zu erhalten

Zur Bestellung und für Rückfragen wenden Sie sich bitte an unsere Service-Abteilung.
 +49 (0) 21 91/7 92 355 •  +49 (0) 21 91/7 92 523 •  service-center@hazet.de

HAZET - WERK Hermann Zerver GmbH & Co. KG •  10 04 61 • 42804 Remscheid • GERMANY
 +49 (0) 21 91 / 7 92-0 •  +49 (0) 21 91 / 7 92-375 (National) •  +49 (0) 21 91 / 7 92-400 (International)
 Gùldenwerther Bahnhofstraße 25 - 29 • 42857 Remscheid • GERMANY •  hazet.de •  info@hazet.de